









1. Product Overview

1.1 Specification

Model	CA-S700-KWN1 (Shield 700)
Available Color	Black
Material	Body: SGCC, Appearance: Plastic+ Aluminum
Dimension	W x H x D = 230 x 536 x 508mm / 9.1 x 21.1 x 20 inch
Net Weight	8.5Kg
M/B Supports	Micro-ATX、ATX
5.25" Drive Bays	1
3.5" Drive Bays	3
2.5" Drive Bays	11 (5 Converted from 3.5" Drive Bays + 6 from 2.5" Drive Rack)
Cooling System Support	Front: 120/140mm Fan x 2, 120mm Radiator X 1 (optional) Top: 120mm Fan x 3 (Optional) , 120/240/360mm Radiator x 1 (Optional) Rear: 120/140mm Fan x 1, 120/140mm Radiator x 1 (Optional)
Expansion Slot	7
I/O Connectors	USB 3.0 x 2, USB 2.0 x 2, Mic-in x 1, Audio out x 1 (supports AC97/HD Audio)
Power Supply Support	ATX PS2 140/160/180mm
Maximum CPU Cooler Height	183mm
Maximum VGA Length	415mm

* Product specifications are subject to change without notice

1.2 Accessory

Figure	Parts Name	Q'ty	Used for
	Standoff Socket	1	Stand-off
	Motherboard Stand off	9	M/B Tray
	6#-32*6mm screw	13	M/B Tray, Power Supply
	M3*5mm screw	6	Optical Drive, 2.5" HDD
	Cable tie	8	Cable Management
	#6-32 * 5 Thumb screw	4	Side Panel
	#6-32 * 5mm screw	6	3.5" HDD
	#6-32 * 10mm screw	2	3.5" HDD

Warning!

1. CPU cooler installation

Before start to install the CPU, please ensure that your CPU-cooler does not exceed 183mm height. Otherwise, it might cause damage to case's side panel and your CPU cooler.

2. VGA card installation

Before start to install the VGA Card, please ensure that your VGA Card does not exceed 415mm length. Otherwise, it might cause damage to case's side panel and your VGA Card.

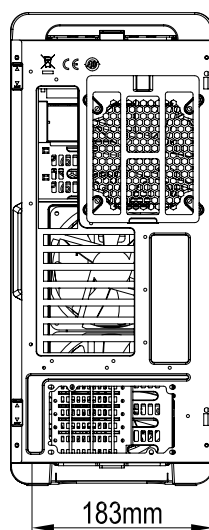

Maximum CPU Cooler Height:183mm

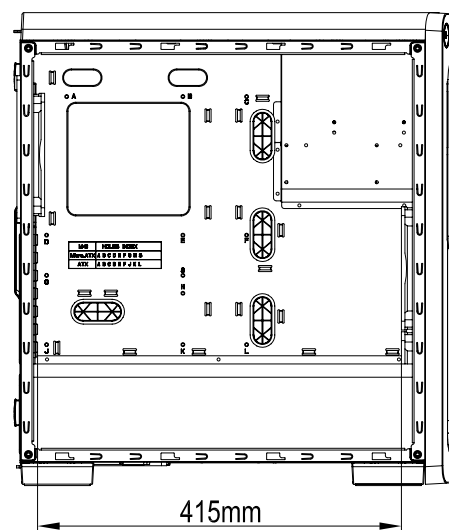

Maximum VGA Card Length:415mm

Exploded View

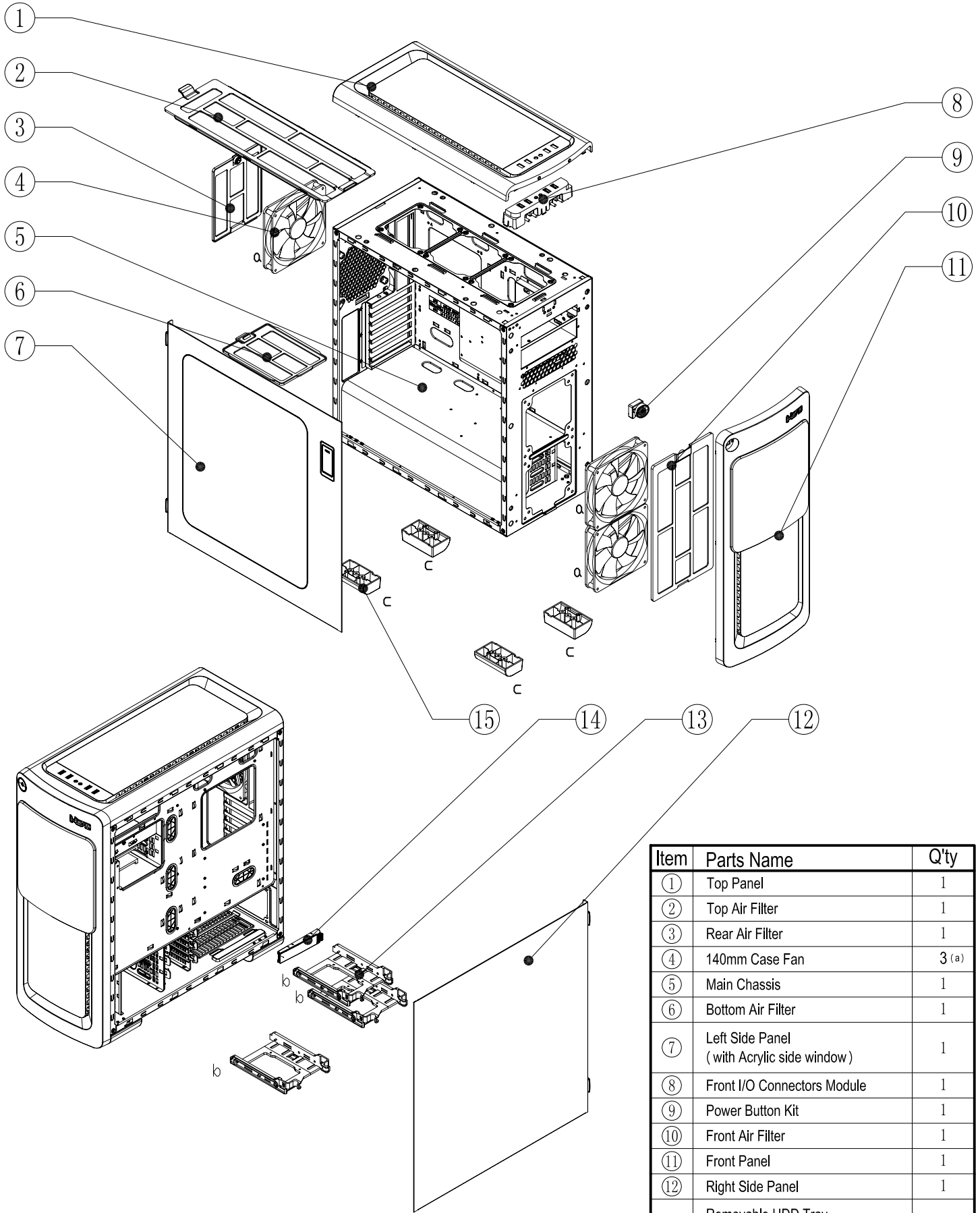

Item	Parts Name	Q'ty
①	Top Panel	1
②	Top Air Filter	1
③	Rear Air Filter	1
④	140mm Case Fan	3 (a)
⑤	Main Chassis	1
⑥	Bottom Air Filter	1
⑦	Left Side Panel (with Acrylic side window)	1
⑧	Front I/O Connectors Module	1
⑨	Power Button Kit	1
⑩	Front Air Filter	1
⑪	Front Panel	1
⑫	Right Side Panel	1
⑬	Removable HDD Tray (Compatible with 3.5" & 2.5" Drives)	3 (b)
⑭	Toolless-Drive Latch (5.25" only)	1
⑮	Plastic Feet	4 (c)